



PL-S

5PL-S/LED/13H/830/IF5/P/2P 20/1

Philips LED PL-S lamps make the transition to LED from CFL lamps as simple as replacing a lamp. The InstantFit (UL Type A) 2-pin PL-S LED lamps are available in a wide array of color temperatures. They quickly and effectively replace 13W 2-pin compact fluorescent PL-S lamps.

Product data

General Information	
Base	GX23 [GX23]
EU RoHS compliant	Yes
Nominal Lifetime (Nom)	50000 h
Switching Cycle	50000X
Light Technical	
Color Code	830 [CCT of 3000K]
Beam Angle (Nom)	120 °
Initial lumen (Nom)	540 lm
Color Designation	White (WH)
Correlated Color Temperature (Nom)	3000 K
Luminous Efficacy (rated) (Nom)	108.00 lm/W
Color Consistency	<6
Color Rendering Index (Nom)	82
LLMF At End Of Nominal Lifetime (Nom)	70 %
Operating and Electrical	
Input Frequency	50 to 60 Hz
Power (Rated) (Nom)	5 W
Lamp Current (Max)	50 mA
Lamp Current (Min)	15 mA
Starting Time (Nom)	0.5 s

Warm Up Time to 60% Light (Nom)	0.5 s
UL Type	Type A - works on ballast
Power Factor (Nom)	0.9
Voltage (Nom)	120-277 V
Temperature	
T-Ambient (Max)	45 °C
T-Ambient (Min)	-20 °C
T-Storage (Max)	65 °C
T-Storage (Min)	-40 °C
T-Case Maximum (Nom)	75 °C
Controls and Dimming	
Dimmable	No
Mechanical and Housing	
Bulb Material	Plastic
Product Length	6.7 in
Approval and Application	
Energy Efficiency Label (EEL)	Not applicable
Energy Saving Product	Yes
Approbation Marks	UL certificate RoHS compliance

PL-S

Energy Consumption kWh/1000 h	- kWh
Product Data	
Order product name	5PL-S/LED/13H/830/IF5/P/2P 20/1
EAN/UPC - Product	046677529567
Order code	529560
Numerator - Quantity Per Pack	1

Numerator - Packs per outer box	20
Material Nr. (12NC)	929001862904
Net Weight (Piece)	0.043 kg
Model Number	9290018629

Dimensional drawing

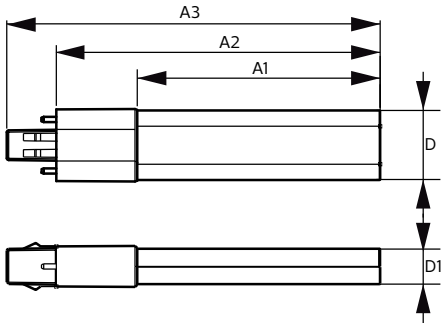

PLED PLS 120-277V 5-13W 580lm 3000K GX23

Product	D	D1	A1	A2	A3
5PL-S/LED/13H/830/IF5/P/2P 20/1	31.1 mm	15.8 mm	108 mm	144 mm	166 mm

Photometric data

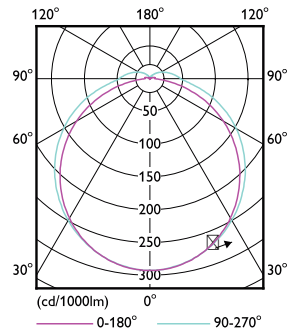
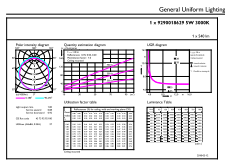

LEDtube PLS 5W GX23 830 2P 12D ND

LEDtube PLS 5W GX23 827 2P 12D ND

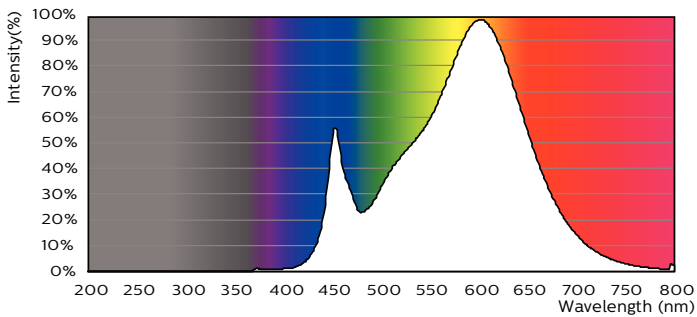

LEDtube PLS 5W GX23 830 2P 12D ND

PL-S

Lifetime

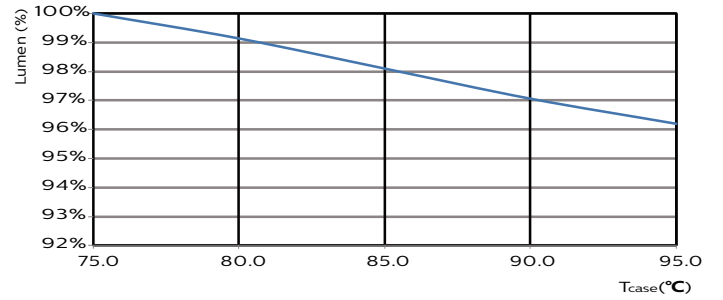
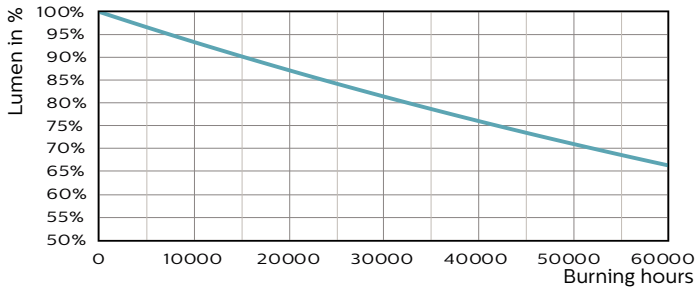

LEDtube PLS 5W GX23 827 2P 12D ND

LEDtube PLS 5W GX23 827 2P 12D ND

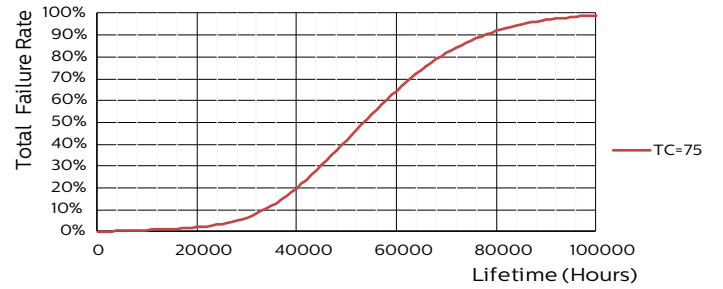
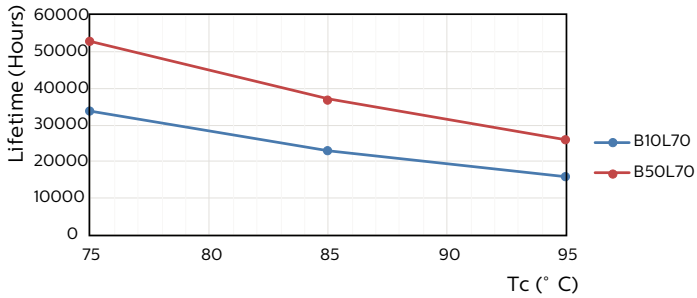

LEDtube PLS 5W GX23 827 2P 12D ND

LEDtube PLS 5W GX23 827 2P 12D ND

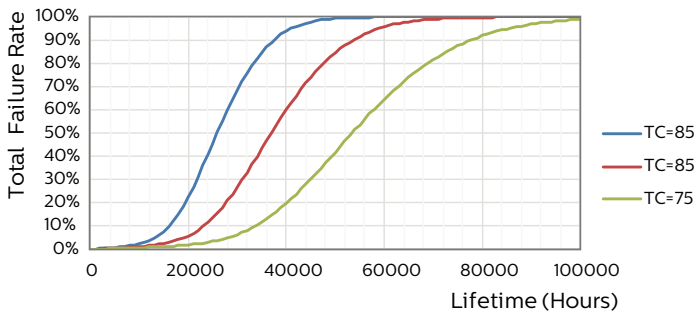

LEDtube PLS 5W GX23 827 2P 12D ND

